

GREEN MOUNTAIN  
WINDOW & DOOR™  
COMPANY

**Classic  
Order  
Guide**

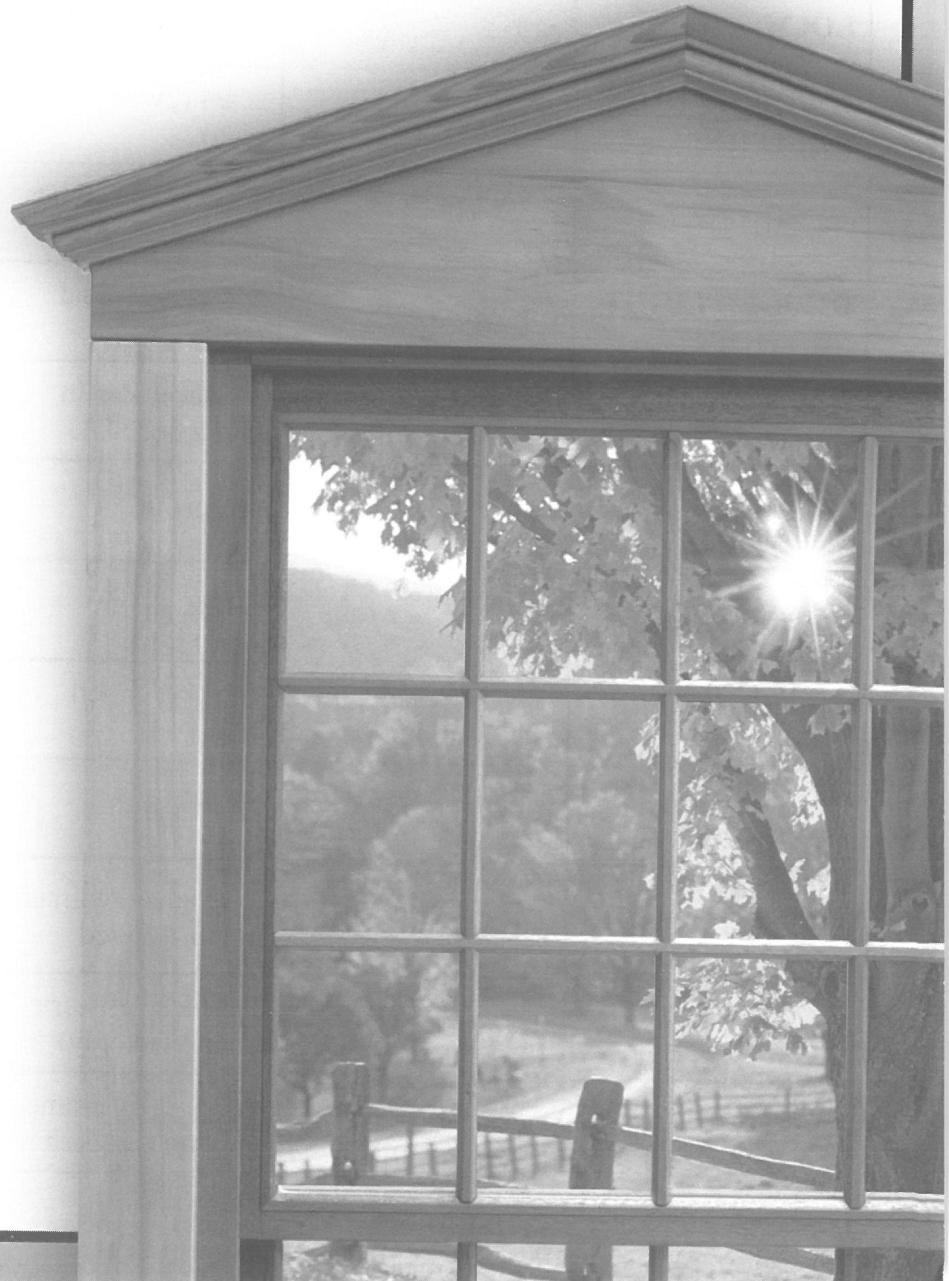

# CLASSIC DOUBLE HUNG SELECTION SHEET

Shaded cells indicate the default choice if no other selection is made

<b>UNIT:</b>				
<b>QUANTITY:</b>				
<b>EXTERIOR:</b>	<input type="checkbox"/> Natural	<input type="checkbox"/> Primed	<input type="checkbox"/> Painted, Color: _____.	<input type="checkbox"/> White Vinyl Clad
<b>INTERIOR:</b>	<input type="checkbox"/> Natural	<input type="checkbox"/> Primed	<input type="checkbox"/> Species Other Than Pine _____.	<input type="checkbox"/> Other _____.
<b>GLAZING:</b>	<input type="checkbox"/> Regular Insulated	<input type="checkbox"/> Low E - Argon	<input type="checkbox"/> Low E - Krypton (non-clad only)	<input type="checkbox"/> Other _____.
<b>SPECIAL GLASS:</b>	<input type="checkbox"/> Tempered	<input type="checkbox"/> Obscure	<input type="checkbox"/> Other _____.	
<b>LOCK:</b>	Standard: <input type="checkbox"/> Bronze <input type="checkbox"/> White	Colonial: <input type="checkbox"/> Brass <input type="checkbox"/> Nickel	<input type="checkbox"/> Oil Rubbed Bronze	<input type="checkbox"/> Other _____.
<b>DIVIDED LIGHT PATTERN:</b>	<input type="checkbox"/> 2/2 (vertical bars)	<input type="checkbox"/> 4/4 (2w2h per sash)	<input type="checkbox"/> 6/6 (3w2h per sash)	<input type="checkbox"/> 8/8 (4w2h per sash)
	<input type="checkbox"/> 9/9 (3w3h per sash)	<input type="checkbox"/> 12/12 (4w3h per sash)	<input type="checkbox"/> Other _____.	
<b>DIVIDED LIGHT METHOD:</b>	<input type="checkbox"/> K.D. Grille	<input type="checkbox"/> Full Surround Grille	<input type="checkbox"/> Airspace Grille	<input type="checkbox"/> 5/8" SDL (non- clad only)
	<input type="checkbox"/> 7/8" SDL	<input type="checkbox"/> Spacer Bar In Glass For SDL	<input type="checkbox"/> Other _____.	
<b>JAMB DEPTH:</b>	<input type="checkbox"/> 4 9/16"	<input type="checkbox"/> 6 9/16"	<input type="checkbox"/> Other _____.	
<b>JAMB LINER:</b>	<input type="checkbox"/> Standard, White	<input type="checkbox"/> Beige		
<b>EXTERIOR CASING:</b>	<input type="checkbox"/> None, Clad Unit Has Nailing Fin	<input type="checkbox"/> None, 4" sill horns	<input type="checkbox"/> Brickmold	<input type="checkbox"/> 5/4 x 4 Flat
	<input type="checkbox"/> 5/4 x 5 Flat	<input type="checkbox"/> 5/4 x 6 Flat	<input type="checkbox"/> No Finger Joints	<input type="checkbox"/> Other _____.
<b>SPECIAL CASING DETAIL:</b>	<input type="checkbox"/> Flat Pediment Head Applied	<input type="checkbox"/> Angled Pediment Head Applied	<input type="checkbox"/> Other _____.	
<b>SILL:</b>	<input type="checkbox"/> Standard	<input type="checkbox"/> Thick "Historic," (non-clad only)	<input type="checkbox"/> No Finger Joints	<input type="checkbox"/> Other _____.
<b>SCREEN:</b>	<input type="checkbox"/> White Frame, Fiberglass Mesh	<input type="checkbox"/> _____ Frame, Fiberglass Mesh	<input type="checkbox"/> Aluminum Mesh	<input type="checkbox"/> Wood Frame, _____ Mesh

GLASS SIZE SASH FRAME ROUGH	SIZE DPG.	SIZE DPG.	SIZE DPG.	SIZE DPG.	SIZE DPG.	SIZE DPG.
9 7/8" 1 1/4" 1 7/8" 1 1/4"	15 9/16" 10 5/16"	15 9/16" 10 5/16"	15 9/16" 10 5/16"	15 9/16" 10 5/16"	15 9/16" 10 5/16"	15 9/16" 10 5/16"
12 5/8" 2 5/8" 2 5/8"	15 9/16" 10 5/16"	15 9/16" 10 5/16"	15 9/16" 10 5/16"	15 9/16" 10 5/16"	15 9/16" 10 5/16"	15 9/16" 10 5/16"
14 10/32" 2 1/8" 2 1/8"	15 9/16" 10 5/16"	15 9/16" 10 5/16"	15 9/16" 10 5/16"	15 9/16" 10 5/16"	15 9/16" 10 5/16"	15 9/16" 10 5/16"
16 2 5/8" 2 5/8" 2 5/8"	15 9/16" 10 5/16"	15 9/16" 10 5/16"	15 9/16" 10 5/16"	15 9/16" 10 5/16"	15 9/16" 10 5/16"	15 9/16" 10 5/16"
18 6 7/8" 2 5/8" 2 5/8"	15 9/16" 10 5/16"	15 9/16" 10 5/16"	15 9/16" 10 5/16"	15 9/16" 10 5/16"	15 9/16" 10 5/16"	15 9/16" 10 5/16"
20 4 1/8" 2 5/8" 2 5/8"	15 9/16" 10 5/16"	15 9/16" 10 5/16"	15 9/16" 10 5/16"	15 9/16" 10 5/16"	15 9/16" 10 5/16"	15 9/16" 10 5/16"
22 4 7/8" 4 5/8" 4 5/8"	15 9/16" 10 5/16"	15 9/16" 10 5/16"	15 9/16" 10 5/16"	15 9/16" 10 5/16"	15 9/16" 10 5/16"	15 9/16" 10 5/16"
24 4 8 7/8" 4 5/8" 4 5/8"	15 9/16" 10 5/16"	15 9/16" 10 5/16"	15 9/16" 10 5/16"	15 9/16" 10 5/16"	15 9/16" 10 5/16"	15 9/16" 10 5/16"
26 4 7/8" 4 5/8" 4 5/8"	15 9/16" 10 5/16"	15 9/16" 10 5/16"	15 9/16" 10 5/16"	15 9/16" 10 5/16"	15 9/16" 10 5/16"	15 9/16" 10 5/16"
28 4 7/8" 4 5/8" 4 5/8"	15 9/16" 10 5/16"	15 9/16" 10 5/16"	15 9/16" 10 5/16"	15 9/16" 10 5/16"	15 9/16" 10 5/16"	15 9/16" 10 5/16"
30 6 7/8" 5 9/8" 5 9/8"	15 9/16" 10 5/16"	15 9/16" 10 5/16"	15 9/16" 10 5/16"	15 9/16" 10 5/16"	15 9/16" 10 5/16"	15 9/16" 10 5/16"
32 6 7/8" 5 9/8" 5 9/8"	15 9/16" 10 5/16"	15 9/16" 10 5/16"	15 9/16" 10 5/16"	15 9/16" 10 5/16"	15 9/16" 10 5/16"	15 9/16" 10 5/16"
34 6 7/8" 5 9/8" 5 9/8"	15 9/16" 10 5/16"	15 9/16" 10 5/16"	15 9/16" 10 5/16"	15 9/16" 10 5/16"	15 9/16" 10 5/16"	15 9/16" 10 5/16"
36 6 7/8" 5 9/8" 5 9/8"	15 9/16" 10 5/16"	15 9/16" 10 5/16"	15 9/16" 10 5/16"	15 9/16" 10 5/16"	15 9/16" 10 5/16"	15 9/16" 10 5/16"

GLASS SIZE SASH FRAME ROUGH	SIZE DPG.	SIZE DPG.	SIZE DPG.
36" 3 3/4" 3 5/16" 3 5/16"	36" 25 6 7/8" 25 6 7/8"	36" 25 6 7/8" 25 6 7/8"	36" 25 6 7/8" 25 6 7/8"
48" 4 4" 4 5/16" 4 5/16"	36" 25 6 7/8" 25 6 7/8"	36" 25 6 7/8" 25 6 7/8"	36" 25 6 7/8" 25 6 7/8"
60" 5 1/8" 5 1/8"	36" 25 6 7/8" 25 6 7/8"	36" 25 6 7/8" 25 6 7/8"	36" 25 6 7/8" 25 6 7/8"
36" 3 3/4" 3 5/16" 3 5/16"	48" 29 10 7/8" 29 10 7/8"	48" 29 10 7/8" 29 10 7/8"	48" 29 10 7/8" 29 10 7/8"
48" 4 4" 4 5/16" 4 5/16"	36" 29 10 7/8" 29 10 7/8"	36" 29 10 7/8" 29 10 7/8"	36" 29 10 7/8" 29 10 7/8"
60" 5 1/8" 5 1/8"	36" 29 10 7/8" 29 10 7/8"	36" 29 10 7/8" 29 10 7/8"	36" 29 10 7/8" 29 10 7/8"
36" 3 3/4" 3 5/16" 3 5/16"	48" 33 2 7/8" 33 2 7/8"	48" 33 2 7/8" 33 2 7/8"	48" 33 2 7/8" 33 2 7/8"
48" 4 4" 4 5/16" 4 5/16"	36" 33 2 7/8" 33 2 7/8"	36" 33 2 7/8" 33 2 7/8"	36" 33 2 7/8" 33 2 7/8"
60" 5 1/8" 5 1/8"	36" 33 2 7/8" 33 2 7/8"	36" 33 2 7/8" 33 2 7/8"	36" 33 2 7/8" 33 2 7/8"
36" 3 3/4" 3 5/16" 3 5/16"	48" 37 6 7/8" 37 6 7/8"	48" 37 6 7/8" 37 6 7/8"	48" 37 6 7/8" 37 6 7/8"
48" 4 4" 4 5/16" 4 5/16"	36" 37 6 7/8" 37 6 7/8"	36" 37 6 7/8" 37 6 7/8"	36" 37 6 7/8" 37 6 7/8"
60" 5 1/8" 5 1/8"	36" 37 6 7/8" 37 6 7/8"	36" 37 6 7/8" 37 6 7/8"	36" 37 6 7/8" 37 6 7/8"
36" 3 3/4" 3 5/16" 3 5/16"	48" 41 10 7/8" 41 10 7/8"	48" 41 10 7/8" 41 10 7/8"	48" 41 10 7/8" 41 10 7/8"
48" 4 4" 4 5/16" 4 5/16"	36" 41 10 7/8" 41 10 7/8"	36" 41 10 7/8" 41 10 7/8"	36" 41 10 7/8" 41 10 7/8"
60" 5 1/8" 5 1/8"	36" 41 10 7/8" 41 10 7/8"	36" 41 10 7/8" 41 10 7/8"	36" 41 10 7/8" 41 10 7/8"
36" 3 3/4" 3 5/16" 3 5/16"	48" 45 2 7/8" 45 2 7/8"	48" 45 2 7/8" 45 2 7/8"	48" 45 2 7/8" 45 2 7/8"
48" 4 4" 4 5/16" 4 5/16"	36" 45 2 7/8" 45 2 7/8"	36" 45 2 7/8" 45 2 7/8"	36" 45 2 7/8" 45 2 7/8"
60" 5 1/8" 5 1/8"	36" 45 2 7/8" 45 2 7/8"	36" 45 2 7/8" 45 2 7/8"	36" 45 2 7/8" 45 2 7/8"
36" 3 3/4" 3 5/16" 3 5/16"	48" 49 6 7/8" 49 6 7/8"	48" 49 6 7/8" 49 6 7/8"	48" 49 6 7/8" 49 6 7/8"
48" 4 4" 4 5/16" 4 5/16"	36" 49 6 7/8" 49 6 7/8"	36" 49 6 7/8" 49 6 7/8"	36" 49 6 7/8" 49 6 7/8"
60" 5 1/8" 5 1/8"	36" 49 6 7/8" 49 6 7/8"	36" 49 6 7/8" 49 6 7/8"	36" 49 6 7/8" 49 6 7/8"
36" 3 3/4" 3 5/16" 3 5/16"	48" 53 10 7/8" 53 10 7/8"	48" 53 10 7/8" 53 10 7/8"	48" 53 10 7/8" 53 10 7/8"
48" 4 4" 4 5/16" 4 5/16"	36" 53 10 7/8" 53 10 7/8"	36" 53 10 7/8" 53 10 7/8"	36" 53 10 7/8" 53 10 7/8"
60" 5 1/8" 5 1/8"	36" 53 10 7/8" 53 10 7/8"	36" 53 10 7/8" 53 10 7/8"	36" 53 10 7/8" 53 10 7/8"
36" 3 3/4" 3 5/16" 3 5/16"	48" 57 2 7/8" 57 2 7/8"	48" 57 2 7/8" 57 2 7/8"	48" 57 2 7/8" 57 2 7/8"
48" 4 4" 4 5/16" 4 5/16"	36" 57 2 7/8" 57 2 7/8"	36" 57 2 7/8" 57 2 7/8"	36" 57 2 7/8" 57 2 7/8"
60" 5 1/8" 5 1/8"	36" 57 2 7/8" 57 2 7/8"	36" 57 2 7/8" 57 2 7/8"	36" 57 2 7/8" 57 2 7/8"
36" 3 3/4" 3 5/16" 3 5/16"	48" 61 10 7/8" 61 10 7/8"	48" 61 10 7/8" 61 10 7/8"	48" 61 10 7/8" 61 10 7/8"
48" 4 4" 4 5/16" 4 5/16"	36" 61 10 7/8" 61 10 7/8"	36" 61 10 7/8" 61 10 7/8"	36" 61 10 7/8" 61 10 7/8"
60" 5 1/8" 5 1/8"	36" 61 10 7/8" 61 10 7/8"	36" 61 10 7/8" 61 10 7/8"	36" 61 10 7/8" 61 10 7/8"

Rough Openings of Muller Units:

- Double Wide Unit: (Single RO x 2) -1"
- Triple Wide Unit: (Single RO x 3) -2"
- Four Wide Unit: (Single RO x 4) -3"

Standard Divided Light Patterns Shown, others available upon request

\* = Cottage Units are available in these frame sizes.  
E = Meets Standard Egress Codes

# CLASSIC CASEMENT SELECTION SHEET

Shaded cells indicate the default choice if no other selection is made

<b>UNIT:</b>	<input type="checkbox"/> Left Hinge <input type="checkbox"/> Right Hinge <input type="checkbox"/> Stationary (choose one)			
<b>QUANTITY:</b>				
<b>EXTERIOR:</b>	<input type="checkbox"/> Natural	<input type="checkbox"/> Primed	<input type="checkbox"/> White Vinyl Clad	<input type="checkbox"/> Painted, Color: _____.
<b>INTERIOR:</b>	<input type="checkbox"/> Natural	<input type="checkbox"/> Primed	<input type="checkbox"/> Other _____.	
<b>GLAZING:</b>	<input type="checkbox"/> Regular Insulated	<input type="checkbox"/> Low E - Argon	<input type="checkbox"/> Other _____.	
<b>SPECIAL GLASS:</b>	<input type="checkbox"/> Tempered	<input type="checkbox"/> Obscure	<input type="checkbox"/> Other _____.	
<b>LOCK:</b>	<input type="checkbox"/> Standard Bronze	<input type="checkbox"/> Standard White	<input type="checkbox"/> Other _____.	
<b>DIVIDED LIGHT PATTERN:</b>	<input type="checkbox"/> 2w2h	<input type="checkbox"/> 2w3h	<input type="checkbox"/> 2w4h	<input type="checkbox"/> 2w5h
	<input type="checkbox"/> 2w6h	<input type="checkbox"/> 3w2h	<input type="checkbox"/> 3w3h	<input type="checkbox"/> 3w4h
	<input type="checkbox"/> 3w5h	<input type="checkbox"/> 3w6h	<input type="checkbox"/> Other _____.	
<b>DIVIDED LIGHT METHOD:</b>	<input type="checkbox"/> K.D. Grille	<input type="checkbox"/> Full Surround Grille	<input type="checkbox"/> Airspace Grille	<input type="checkbox"/> 5/8" SDL (non-clad only)
	<input type="checkbox"/> 7/8" SDL	<input type="checkbox"/> Spacer Bar In Glass For SDL	<input type="checkbox"/> Other _____.	
<b>JAMB DEPTH:</b>	<input type="checkbox"/> 4 9/16"	<input type="checkbox"/> 6 9/16"	<input type="checkbox"/> Other _____.	
<b>EXTERIOR CASING:</b>	<input type="checkbox"/> None, Clad Unit Has Nailing Fin	<input type="checkbox"/> None, 4" sill horns	<input type="checkbox"/> Brickmold	<input type="checkbox"/> 5/4 x 4 Flat
	<input type="checkbox"/> 5/4 x 5 Flat	<input type="checkbox"/> 5/4 x 6 Flat	<input type="checkbox"/> No Finger Joints	<input type="checkbox"/> Other _____.
<b>SPECIAL CASING DETAIL:</b>	<input type="checkbox"/> Flat Pediment Head Applied	<input type="checkbox"/> Angled Pediment Head Applied	<input type="checkbox"/> Other _____.	
<b>SILL:</b>	<input type="checkbox"/> Standard	<input type="checkbox"/> Thick "Historic," (non-clad only)	<input type="checkbox"/> No Finger Joints	<input type="checkbox"/> Other _____.
<b>SCREEN:</b>	<input type="checkbox"/> White Frame, Fiberglass Mesh	<input type="checkbox"/> _____ Frame, Fiberglass Mesh	<input type="checkbox"/> Aluminum Mesh	

Clad Wood R.O. Frame R.O. Glass Size	CCMTR1616	CCMTR2016	CCMTR2416	CCMTR2816	CCMTR3216								
4' 1/2" 5' 1/4" 1' 1/4" 10 3/4"													
1' 5" 1' 9" 1' 4" 1' 2 3/4"						CCM4024 PICT	CCM4824 PICT	CCM6024 PICT	CCM7224 PICT				
2' 1/2" 2' 1 1/4" 2' 5/8" 2' 6 3/4"						CCM4032 PICT	CCM4832 PICT	CCM6032 PICT	CCM7232 PICT				
3' 1/2" 3' 1 1/4" 3' 5/8" 3' 6 3/4"						CCM4036 PICT	CCM4836 PICT	CCM6036 PICT	CCM7236 PICT				
4' 1/2" 4' 5/8" 4' 1 1/4" 4' 2 10 3/4"						CCM4040 PICT	CCM4840 PICT	CCM6040 PICT	CCM7240 PICT				
4' 1/2" 4' 1 1/4" 4' 5/8" 4' 6 3/4"						CCM4048 PICT	CCM4848 PICT	CCM6048 PICT	CCM7248 PICT				
4' 8 1/2" 4' 9 1/4" 4' 2 3/4"						CCM4056 PICT	CCM4856 PICT	CCM6056 PICT	CCM7256 PICT				
5' 1/2" 5' 1 1/4" 5' 5/8" 5' 6 3/4"						CCM4060 PICT	CCM4860 PICT	CCM6060 PICT	CCM7260 PICT				
5' 4 1/2" 5' 5 1/4" 5' 2 3/4"						CCM4064 PICT	CCM4864 PICT	CCM6064 PICT	CCM7264 PICT				
6' 1/2" 6' 1 3/4" 6' 5/8" 6' 6 3/4"						CCM4072 PICT	CCM4872 PICT	CCM6072 PICT	CCM7272 PICT				

E = Meets national egress codes.

EH = Meets egress codes only with egress hinges.

Standard divided lights shown, others available upon request.

All units depicting hinges can be either left hinge, right hinge, or stationary center.

Ex: Left hinge has hinge on left side of frame from the exterior view.

Note: All frame heights listed do not include 3/4" sub sill.

# CLASSIC AWNING SELECTION SHEET

Shaded cells indicate the default choice if no other selection is made

<b>UNIT:</b>	<input type="checkbox"/> Operating <input type="checkbox"/> Stationary (choose one)			
<b>QUANTITY:</b>				
<b>EXTERIOR:</b>	<input type="checkbox"/> Natural	<input type="checkbox"/> Primed	<input type="checkbox"/> White Vinyl Clad	<input type="checkbox"/> Painted, Color: _____.
<b>INTERIOR:</b>	<input type="checkbox"/> Natural	<input type="checkbox"/> Primed	<input type="checkbox"/> Other _____.	
<b>GLAZING:</b>	<input type="checkbox"/> Regular Insulated	<input type="checkbox"/> Low E - Argon	<input type="checkbox"/> Other _____.	
<b>SPECIAL GLASS:</b>	<input type="checkbox"/> Tempered	<input type="checkbox"/> Obscure	<input type="checkbox"/> Other _____.	
<b>LOCK:</b>	<input type="checkbox"/> Standard Bronze	<input type="checkbox"/> Standard White	<input type="checkbox"/> Other _____.	
<b>DIVIDED LIGHT PATTERN:</b>	<input type="checkbox"/> 2w2h	<input type="checkbox"/> 2w3h	<input type="checkbox"/> 3w2h	<input type="checkbox"/> 3w3h
	<input type="checkbox"/> 4w2h	<input type="checkbox"/> 4w3h	<input type="checkbox"/> Other _____.	
<b>DIVIDED LIGHT METHOD:</b>	<input type="checkbox"/> K.D. Grille	<input type="checkbox"/> Full Surround Grille	<input type="checkbox"/> Airspace Grille	<input type="checkbox"/> 5/8" SDL (non-clad only)
	<input type="checkbox"/> 7/8" SDL	<input type="checkbox"/> Spacer Bar In Glass For SDL	<input type="checkbox"/> Other _____.	
<b>JAMB DEPTH:</b>	<input type="checkbox"/> 4 9/16"	<input type="checkbox"/> 6 9/16"	<input type="checkbox"/> Other _____.	
<b>EXTERIOR CASING:</b>	<input type="checkbox"/> None, Clad Unit Has Nailing Fin	<input type="checkbox"/> None, 4" sill horns	<input type="checkbox"/> Brickmold	<input type="checkbox"/> 5/4 x 4 Flat
	<input type="checkbox"/> 5/4 x 5 Flat	<input type="checkbox"/> 5/4 x 6 Flat	<input type="checkbox"/> No Finger Joints	<input type="checkbox"/> Other _____.
<b>SPECIAL CASING DETAIL:</b>	<input type="checkbox"/> Flat Pediment Head Applied	<input type="checkbox"/> Angled Pediment Head Applied	<input type="checkbox"/> Other _____.	
<b>SILL:</b>	<input type="checkbox"/> Standard	<input type="checkbox"/> Thick "Historic," (non-clad only)	<input type="checkbox"/> No Finger Joints	<input type="checkbox"/> Other _____.
<b>SCREEN:</b>	<input type="checkbox"/> Match Hardware, Fiberglass Mesh	<input type="checkbox"/> _____ Frame, Fiberglass Mesh	<input type="checkbox"/> Aluminum Mesh	

	1' 4 1/2" 1' 5 1/4" 1' 4" 1' 10 3/4"							
	CAWTR1616	CAWTR2016	CAWTR2416	CAWTR2816	CAWTR3216	CAWTR3616	CAWTR4016	CAWTR4816
Clad R.D. Wood R.D. Frame Glass Size	1' 5" 1' 5" 1' 4" 10 3/4"	1' 9" 1' 9" 1' 8" 1' 2 3/4"	2' 1" 2' 1" 1' 6 3/4"	2' 5" 2' 5" 2' 4" 1' 10 3/4"	2' 9" 2' 9" 2' 8" 2' 3/4"	3' 1" 3' 1" 2' 6 3/4"	3' 5" 3' 5" 2' 4" 2' 10 3/4"	4' 1" 4' 1" 4' 4" 3' 6 3/4"
	1' 8 1/2" 1' 9 1/4" 1' 8" 1' 2 3/4"							
	CAW1620	CAW2020	CAW2420	CAW2820	CAW3220	CAW3620	CAW4020	CAW4820
	2' 1/2" 2' 1 1/4" 2' 1" 2' 6 3/4"							
	CAW1624	CAW2024	CAW2424	CAW2824	CAW3224	CAW3624	CAW4024	CAW4824
	2' 4 1/2" 2' 5 1/4" 2' 4" 1' 10 3/4"							
	CAW1628	CAW2028	CAW2428	CAW2828	CAW3228	CAW3628	CAW4028	CAW4828
	2' 8 1/2" 2' 9 1/4" 2' 8" 2' 2 3/4"							
	CAW1632	CAW2032	CAW2432	CAW2832	CAW3232	CAW3632	CAW4032	CAW4832
	3' 1/2" 3' 1 1/4" 3' 1" 3' 6 3/4"							
	CAW1636	CAW2036	CAW2436	CAW2836	CAW3236	CAW3636	CAW4036	CAW4836

All units depicting hinges can be operating or stationary units.  
 Note: All frame heights listed do not include 3/4" sub sill.









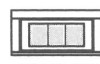

# SWING OR FRENCH SLIDING DOOR SELECTION SHEET

Shaded cells indicate the default choice if no other selection is made

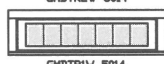
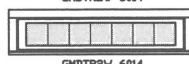
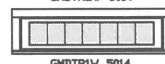
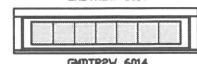
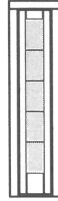
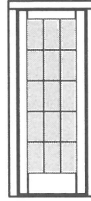
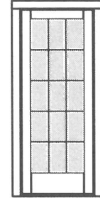
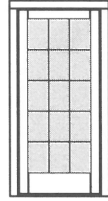
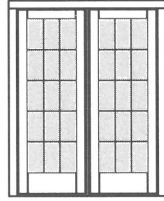
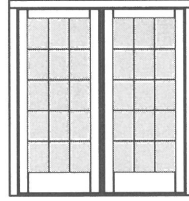
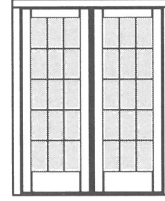
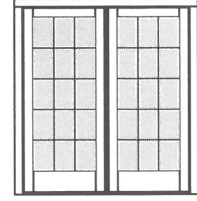
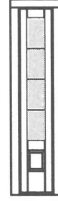
<b>UNIT:</b>	(Specify Operation)			
<b>QUANTITY:</b>				
<b>EXTERIOR:</b>	<input type="checkbox"/> Natural	<input type="checkbox"/> Primed	<input type="checkbox"/> Painted, Color: _____.	<input type="checkbox"/> Other: _____.
<b>INTERIOR:</b>	<input type="checkbox"/> Natural	<input type="checkbox"/> Primed	<input type="checkbox"/> Other _____.	
<b>GLAZING:</b>	<input type="checkbox"/> Regular Insulated	<input type="checkbox"/> Low E - Argon	<input type="checkbox"/> Low E – Krypton	<input type="checkbox"/> Other _____.
<b>SWING DOOR HARDWARE:</b>	<input type="checkbox"/> No Bore <input type="checkbox"/> Single Bore <input type="checkbox"/> Double Bore	<input type="checkbox"/> Brass Multipoint	<b>Special Finish</b> <input type="checkbox"/> Oil Rb Brnz <input type="checkbox"/> Nickel <input type="checkbox"/> Antique Brass	<input type="checkbox"/> Polished Chrome
<b>SLIDING DOOR HARDWARE:</b>	<input type="checkbox"/> Brass Handle	<b>Special Finish:</b> <input type="checkbox"/> Oil Rb Brnz <input type="checkbox"/> Nickel <input type="checkbox"/> Antique Brass	<input type="checkbox"/> Polished Chrome	
<b>DIVIDED LIGHT PATTERN:</b>	<input type="checkbox"/> 2w2h	<input type="checkbox"/> 2w3h	<input type="checkbox"/> 2w4h	<input type="checkbox"/> 2w5h
	<input type="checkbox"/> 3w2h	<input type="checkbox"/> 3w3h	<input type="checkbox"/> 3w4h	<input type="checkbox"/> 3w5h
	<input type="checkbox"/> 2w6h	<input type="checkbox"/> 3w6h	<input type="checkbox"/> Other _____.	
<b>DIVIDED LIGHT METHOD:</b>	<input type="checkbox"/> Full Surround Grille	<input type="checkbox"/> Airspace Grille	<input type="checkbox"/> 5/8" SDL	<input type="checkbox"/> 7/8" SDL
<b>SPACER FOR DIVIDED LIGHT:</b>	No	Yes	<input type="checkbox"/> Gray <input type="checkbox"/> Black	
<b>JAMB DEPTH:</b>	<input type="checkbox"/> 4 9/16"	<input type="checkbox"/> 6 9/16"	<input type="checkbox"/> 7 9/16"	<input type="checkbox"/> Other _____.
<b>EXTERIOR CASING:</b>	<input type="checkbox"/> None	<input type="checkbox"/> Brickmold	<input type="checkbox"/> 5/4 x 4 Flat	<input type="checkbox"/> 5/4 x 5 Flat
	<input type="checkbox"/> 5/4 x 6 Flat	<input type="checkbox"/> No Finger Joints	<input type="checkbox"/> Other _____.	
<b>SPECIAL CASING DETAIL:</b>	<input type="checkbox"/> Flat Pediment Head Applied	<input type="checkbox"/> Angled Pediment Head Applied	<input type="checkbox"/> Other _____.	
<b>SILL: (choices are for swing door only)</b>	<input type="checkbox"/> Bronze Anodized Aluminum	<input type="checkbox"/> Mahogany	<input type="checkbox"/> Other _____.	
<b>SCREEN:</b>	<input type="checkbox"/> White Sliding Aluminum with Fiberglass Mesh	<input type="checkbox"/> _____ Sliding Aluminum with Fiberglass Mesh	<input type="checkbox"/> Wood Swinging with Fiberglass Mesh	<input type="checkbox"/> Wood Swinging with Aluminum Mesh

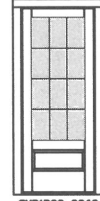
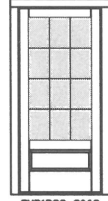

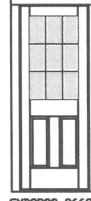
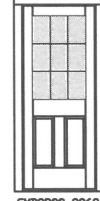
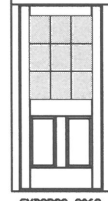
# 6-8 Swing Doors



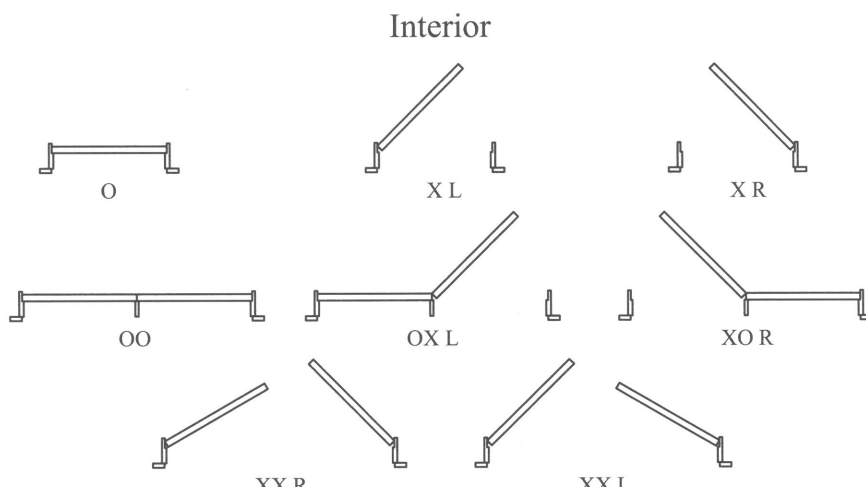

								
	GMDTR1V 1214	GMDTR1V 2614	GMDTR1V 2814	GMDTR1V 3014	GMDTR1V 5014	GMDTR2V 6014	GMDTR1V 5014	GMDTR2V 6014
Rough Opening Frame	1' 4 3/8" 1' 4 3/8" 1' 4"	2' 8 1/2" 2' 7 1/2"	2' 10 1/2" 2' 9 1/2"	3' 2 1/2" 3' 1 1/2"	5' 3 1/4" 5' 2 1/4"	6' 3 1/4" 6' 2 1/4"	5' 3 1/4" 5' 2 1/4"	6' 3 1/4" 6' 2 1/4"
								
	GMDFLSL 1268 O	GMDFLSS 2668 O, XL, or XR	GMDFLSS 2868 O, XL or XR	GMDFLSS 3068 O, XL or XR	GMDFLSS 5068 OO, OXL or XOR	GMDFLSS 6068 OO, OXL or XOR	GMDFLDS 5068 OO, XXL or XOR	GMDFLDS 6068 OO, XXL or XOR
								
	GMDPSSL 1268 O	GMDPSS 2668 O, XL, or XR	GMDPSS 2868 O, XL or XR	GMDPSS 3068 O, XL or XR				
								
	GMDPSSL 1268 O	GMDPSS 2668 O, XL, or XR	GMDPSS 2868 O, XL or XR	GMDPSS 3068 O, XL or XR				
								
	GMD6PSS 2668 O, XL or XR	GMD6PSS 3068 O, XL or XR						

Interior

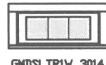

Exterior

# 6-8 French Sliding Doors

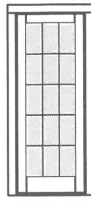
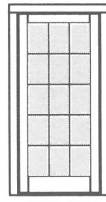
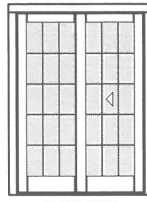
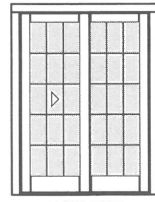
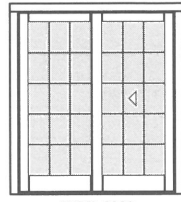
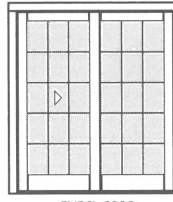
						
	GMDSLTR1V 2614	GMDSLTR1V 3014	GMDSLTR1V 5014	GMDSLTR1V 5014	GMDSLTR1V 6014	GMDSLTR1V 6014
Rough Opening Frame	2' 7 1/4" 2' 6 1/4"	3' 1 1/4" 3' 1/4"	4' 11 3/4" 4' 10 3/4"	4' 11 3/4" 4' 10 3/4"	5' 11 5/8" 5' 10 5/8"	5' 11 5/8" 5' 10 5/8"
						
	GMDSL 2668 O	GMDSL 3068 O	GMDSL 5068 OX	GMDSL 5068 XO	GMDSL 6068 OX	GMDSL 6068 XO

All elevations shown are from the exterior view.

Note: Standard divided light patterns shown, others available upon request.

## HARDWARE OPTIONS

### DOUBLE HUNG WINDOW

Standard Lock on  
"Classic" & "Milestone"



Colonial Option for  
"Classic" & "Milestone"



### CASEMENT & AWNING WINDOW

Standard Lock & Operator on  
"Classic" Series Only

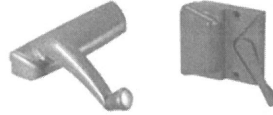

Push-out Lever on  
"Milestone" Series Only

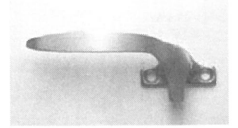

### SWINGING PATIO DOOR

Standard Lever with Multi-point Lock

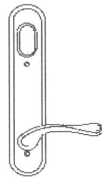

### SLIDING PATIO DOOR

Standard Handle and Lock

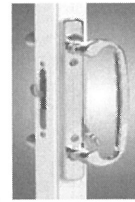

## SILL OPTIONS

### WINDOWS

Standard Sill on  
"Classic" & "Milestone"



Historic Sill Option for  
"Classic" & "Milestone"

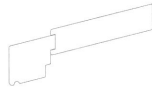

### SWING DOORS

Standard Bronze  
Anodized Aluminum



Mahogany Sill Option  
for In-swing Doors



## HEAD CASING OPTIONS



**FLAT PEDIMENT**

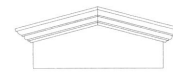

**ANGLED PEDIMENT**

## DIVIDED LITE OPTIONS



I.G., No Lites  
Wood Bead



I.G., No Lites  
Vinyl Bead



No Lites  
Single Glass



5/8" SDL



7/8" SDL



7/8" Grille



Flat Airspace



Profile Airspace



5/8" SDL  
with Spacer Bar



7/8" SDL  
with Spacer Bar

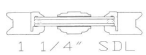

1 1/4" SDL

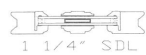

1 1/4" SDL  
with Spacer Bar



I.G., 7/8" SDL  
Vinyl Bead



I.G., 7/8" SDL  
with Spacer Bar  
Vinyl Bead



5/8" TDL  
Single Glass  
Putty Glaze



5/8" TDL  
Single Glass  
Wood Bead

# Cross Sections for Classic Series Window & Green Mountain Door

(Wood Exterior)

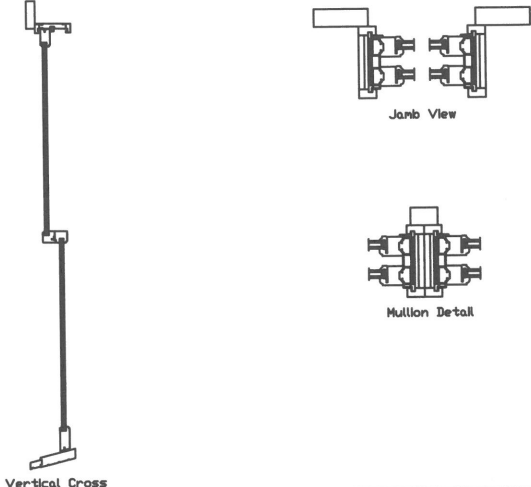
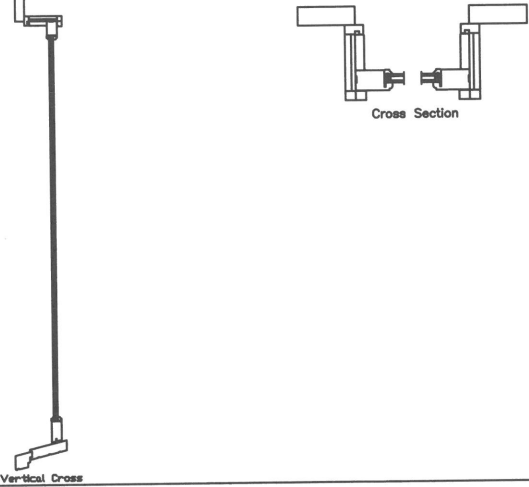
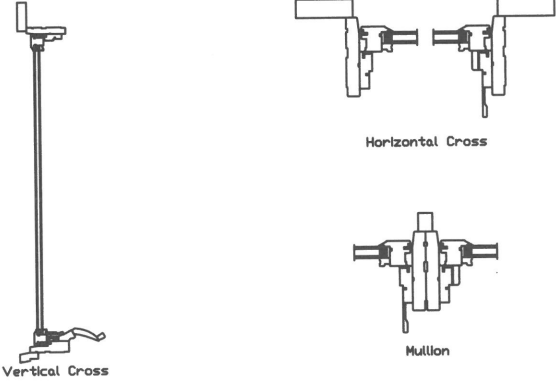
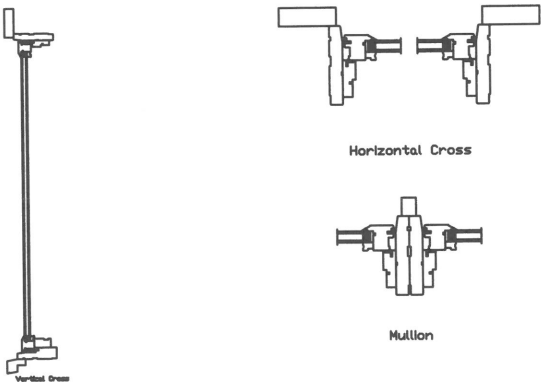
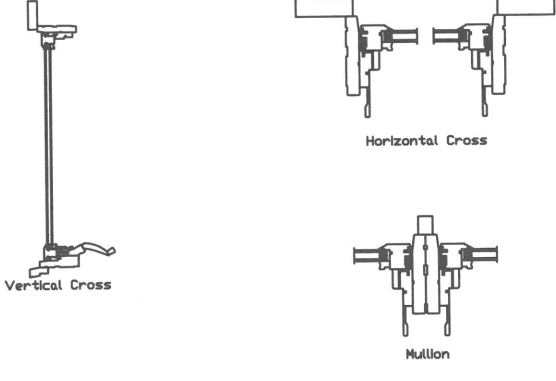
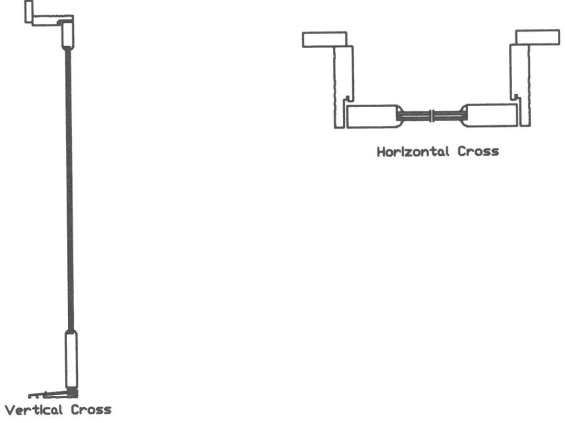
 <p style="text-align: center;">Vertical Cross</p> <p style="text-align: center;">Joint View</p> <p style="text-align: center;">Mullion Detail</p>	 <p style="text-align: center;">Vertical Cross</p> <p style="text-align: center;">Cross Section</p>
<b>Classic Double Hung</b>	<b>Double Hung Picture with Historic Sill Nose</b>
 <p style="text-align: center;">Vertical Cross</p> <p style="text-align: center;">Horizontal Cross</p> <p style="text-align: center;">Mullion</p>	 <p style="text-align: center;">Vertical Cross</p> <p style="text-align: center;">Horizontal Cross</p> <p style="text-align: center;">Mullion</p>
<b>Classic Casement</b>	<b>Classic Cmt./Awn. Picture with Historic Nose</b>
 <p style="text-align: center;">Vertical Cross</p> <p style="text-align: center;">Horizontal Cross</p> <p style="text-align: center;">Mullion</p>	 <p style="text-align: center;">Vertical Cross</p> <p style="text-align: center;">Horizontal Cross</p>
<b>Classic Awning</b>	<b>Swing Door</b>

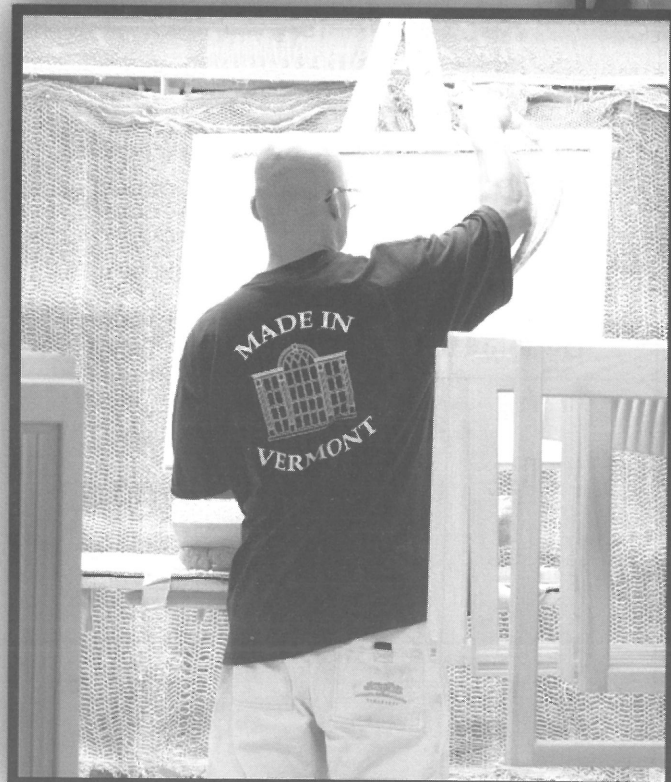

*Tradition  
&  
Technology*

Founded in 1993, the Green Mountain Window & Door™ Company integrates the latest technology with good old-fashioned Yankee craftsmanship. At our plant in Rutland, Vermont we tailor our product to your needs by controlling the entire manufacturing process. We manufacture our own high performance insulating glass. We apply primer and paint using the Cabot Factory Finish System in our paint department. And we hand assemble and sand each window in our production department. Additionally, we use SFI-certified pine and FSC-certified mahogany to help assure the longevity of our natural resources.

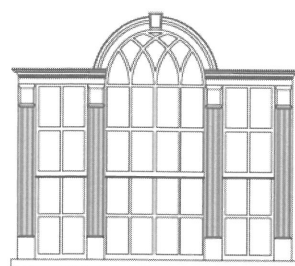

GREEN MOUNTAIN  
WINDOW & DOOR™  
COMPANY

92 Park Street  
Rutland, Vermont 05701  
Phone: 802.747.6915  
Fax: 802.747.7864  
[www.greenmountainwindow.com](http://www.greenmountainwindow.com)